

Technical data sheet

Central hanger for cable tray, side height 60 mm FT

Item number: 6358752



Centre suspension for cable trays with rolled side rail of side height 60 mm. The centre suspension possesses a rotatable M10 threaded sleeve. When filling, ensure an even distribution of the load (avoid one-sided filling).

The widths 100, 150 and 200 mm have additional base perforations, in order to screw the centre suspensions to the tray base when used for the maintenance of electrical functionality according to DIN 4102 Part 12.

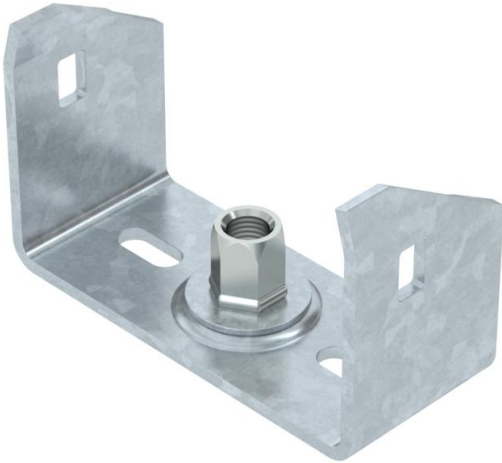

St Steel

FT Hot-dip galvanised

Master data

Item number	6358752
Type	MAH 60 100 FT
Description 1	Centre suspension
Description 2	for cable tray
Manufacturer	OBO
Dimension	B100mm
Material	Steel
Surface	Hot-dip galvanised
Surface standard	DIN EN ISO 1461
Smallest sales unit	1
Unit of quantity	Piece
Weight	18.5 kg
Weight unit	kg/100 pc.

Technical data sheet

Central hanger for cable tray, side height 60 mm FT



Item number: 6358752

Dimensions

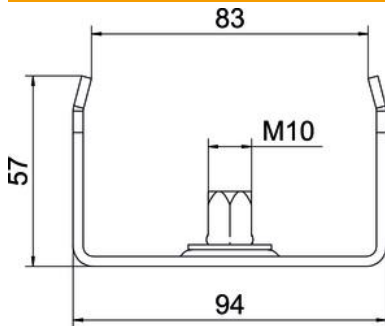

Length	40 mm
Width	100 mm
Width	4 in
Height	57 mm
Dimension B	94 mm
Dimension b	84 mm
Dimension B1	84 mm

Technical data

Version for	Suspended
F in kN	1.3 kN
Maintain electrical functions	no
for width max.	100 mm
for width min.	100
Suitable for metric threaded rod	10
Suitable for tray/ladder width	100 mm
Hole diameter	10.5 mm
Adjustable	no