

Technical data sheet

MMS-plus V 12x110 pre-push tie, with connection thread

Item number: 3498196



Bolt tie for direct mounting without additional anchors in cracked and uncracked concrete and masonry. With connection thread and washer to accept large loads. Suitable for fastening suspended loads from suspended supports and wall brackets in push-through mounting.

Construction product tested according to EAD and CE mark, with European Technical Assessment (ETA) and proof of suitability. Load-bearing capacities under fire loads proven up to fire resistance class R120.



St Steel

VZ galvanised

Master data

Item number	3498196
Type	MMS+ V 12x110
Description 1	Pre-set anchor
Description 2	with connection thread
Manufacturer	OBO
Dimension	12x110
Material	Steel
Surface	galvanised
Surface standard	
Smallest sales unit	25
Unit of quantity	Piece
Weight	6.9 kg
Weight unit	kg/100 pc.

Technical data sheet

MMS-plus V 12x110 pre-push tie, with connection thread

Item number: 3498196



Dimensions

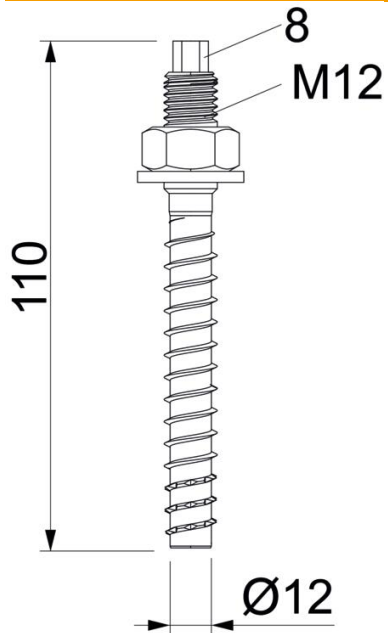

Dimension	12x110
Length	110 mm
Dimension L	110 mm

Technical data

Drill hole diameter, min.	10 mm
Head shape	Miscellaneous
WAF	8
Screw system	Hexagonal