

Technical data sheet

Hook-head screw A4

Item number: 1148150



Hook-head screw for use with MS4022 profile rail



A4 Stainless steel

2B Bright, treated

Master data

Item number	1148150
Type	MS40HB M8x30 A4
Description 1	Hook-head screw
Description 2	for profile rail MS4022
Manufacturer	OBO
Dimension	M8x30mm
Material	Stainless steel
Surface	Bright, treated
Surface standard	
Smallest sales unit	50
Unit of quantity	Piece
Weight	5.65 kg
Weight unit	kg/100 pc.

Technical data sheet

Hook-head screw A4

Item number: 1148150



Dimensions

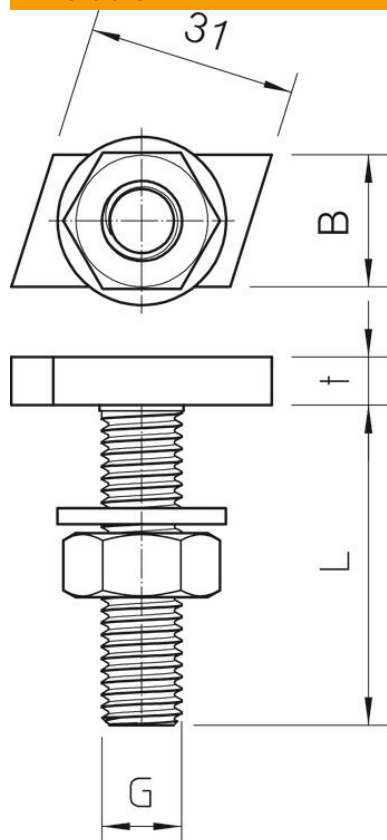

Length	35 mm
Width	17 mm
Height	10 mm

Technical data

Torque	7.1 Nm
Suitable for mounting rail	yes
Thread	M8x30mm
Thread metric	8