

# Technical data sheet

## Hammer-head bolt ZL

Item number: 1148310



Hammer-head bolt for use with MS4121 and MS4141 profile rails

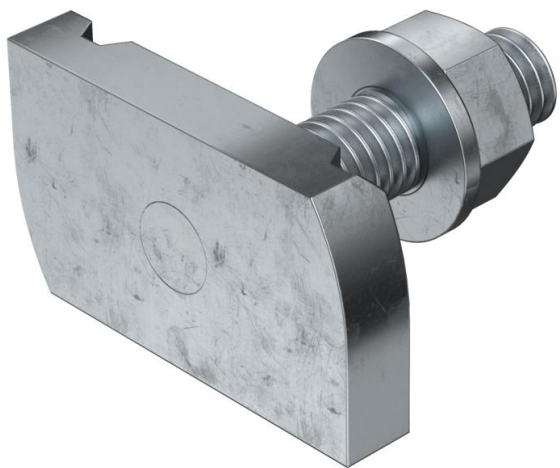

**St** Steel

**ZL** Zinc slat

### Master data

Item number	1148310
Type	MS41HB M8x30 ZL
Description 1	Hammerhead screw
Description 2	for profile rail MS4121/4141
Manufacturer	OBO
Dimension	M8x30mm
Material	Steel
Surface	Zinc slat
Surface standard	
Smallest sales unit	50
Unit of quantity	Piece
Weight	4.85 kg
Weight unit	kg/100 pc.

# Technical data sheet

## Hammer-head bolt ZL

Item number: 1148310



### Dimensions

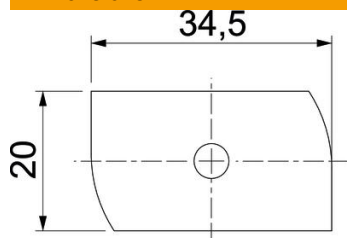

Length	34.5 mm
Width	20 mm
Height	6 mm
Dimension H	6 mm
Dimension L	30 mm

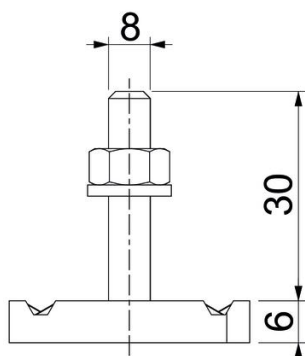

### Technical data

Torque	8 Nm
Suitable for mounting rail	yes
Thread	M 8 x 30
Washer Ø	16 mm