

# Technical data sheet

## Profile rail MS 22 L FT

Item number: 1122719



Heavy-duty C profile rail for individual installation of support constructions, e.g. for cable trays or as a panel for switchgear cabinets. Can also be used for cable routing, in conjunction with clamp clips with a U foot.



**St** Steel

**FT** Hot-dip galvanised

### Master data

Item number	1122719
Type	MS 22 L 600 FT
Description 1	Profile rail
Description 2	perforated, slot 18mm
Manufacturer	OBO
Dimension	600x40x22,5
Material	Steel
Surface	Hot-dip galvanised
Surface standard	DIN EN ISO 1461
Smallest sales unit	1
Unit of quantity	Piece
Weight	91 kg
Weight unit	kg/100 pc.

# Technical data sheet

## Profile rail MS 22 L FT

Item number: 1122719



### Dimensions

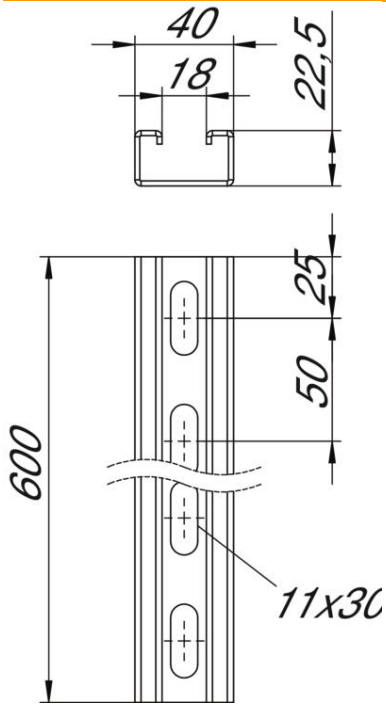

Length	600 mm
Width	40 mm
Height	22.5 mm
Dimension L	600 mm

### Technical data

Breakable	no
Type of perforation	Perforated back
Version for	Single profile
Drill hole spacing, centre	50 mm
Maintain electrical functions	no
Hole size	11x30 mm
Material thickness	2 mm
With perforation	yes
With tothing	no
Profile shape	C profile
Slot width	18 mm
Static value A	1.74 cm <sup>2</sup>
Static value Iy	1.19 cm
Static value Iz	4.46 cm
Static value Wy	1.05 cm <sup>2</sup>
Static value Wz	2.23 cm <sup>2</sup>