

Technical data sheet

Height adjustment unit for lid butt support, trunking height
170-245 mm
Item number: 7424846



For central support of a lid butt support of nominal width 400, 500 or 600.



St Steel

FS Strip galvanized

Master data

Item number	7424846
Type	NE DSU2 17075
Description 1	DSU height-adjustment unit
Description 2	for OKA-G
Manufacturer	OBO
Material	Steel
Surface	Strip galvanized
Surface standard	DIN EN 10346
Smallest sales unit	3
Unit of quantity	Piece
Weight	7.45 kg
Weight unit	kg/100 pc.

Technical data sheet

Height adjustment unit for lid butt support, trunking height
170-245 mm

Item number: 7424846



Dimensions

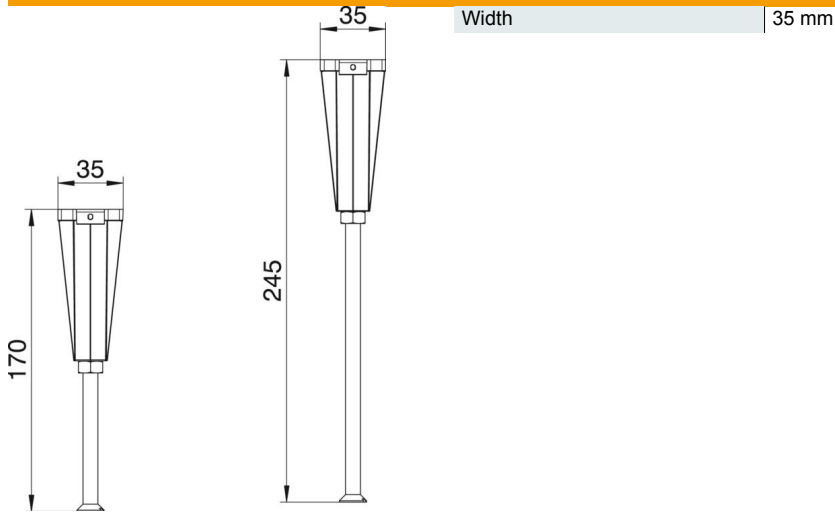

Technical data

Type of accessory	Miscellaneous
Decouplable	no
Suitable for screed-flush closed underfloor ducts	no
Device support to accept mounting boxes	no
Trunking height, max.	245 mm
Duct height, min.	170 mm
Minimum screed height	40
Height-adjustment range, max.	245 mm
Height-adjustment range, min.	170 mm
Accessories	yes
Spare part	no