

Technical data sheet

90° Magic bend 110 FS

Item number: 6041846



90° bend with quick connector system. For all cable tray types of 110 mm side height.



St Steel

FS Strip galvanized

Master data

Item number	6041846
Type	RBM 90 140 FS
Description 1	90° bend
Description 2	with quick connector
Manufacturer	OBO
Dimension	110x400
Material	Steel
Surface	Strip galvanized
Surface standard	DIN EN 10346
Smallest sales unit	1
Unit of quantity	Piece
Weight	323.6 kg
Weight unit	kg/100 pc.

Technical data sheet

90° Magic bend 110 FS

Item number: 6041846



Dimensions

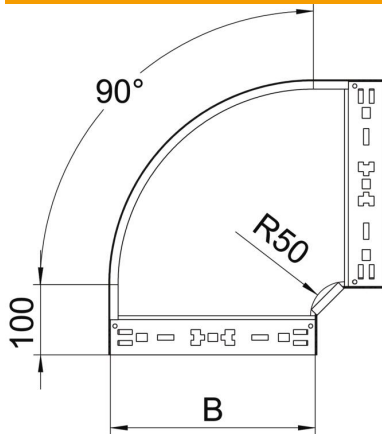

Width	400 mm
Height	110 mm
Plate thickness	1.25 mm
Dimension B	400 mm

Technical data

Bend (angle)	90°
Connector version	Integrated connector
Maintain electrical functions	no
Mounting perforation in base	no
NATO hole pattern	no
Change of direction	Horizontal
Rustproof steel, pickled	no
Side perforation	no
Wide-span version	no
Type of connector, cable support system	Click fastening