

Technical data sheet

90° Magic bend 60 A2

Item number: 6041190



90° bend with quick connector system. For all cable tray types of 60 mm side height.



A2 Stainless steel

2B Bright, treated

Master data

Item number	6041190
Type	RBM 90 650 A2
Description 1	90° bend
Description 2	with quick connector
Manufacturer	OBO
Dimension	60x500
Material	Stainless steel
Surface	Bright, treated
Surface standard	
Smallest sales unit	1
Unit of quantity	Piece
Weight	376.3 kg
Weight unit	kg/100 pc.

Technical data sheet

90° Magic bend 60 A2

Item number: 6041190



Dimensions

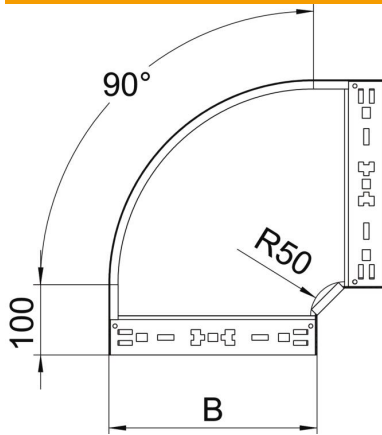

Width	500 mm
Height	60 mm
Plate thickness	1.25 mm
Dimension B	500 mm

Technical data

Bend (angle)	90°
Connector version	Integrated connector
Maintain electrical functions	no
Mounting perforation in base	no
NATO hole pattern	no
Change of direction	Horizontal
Rustproof steel, pickled	no
Side perforation	no
Wide-span version	no
Type of connector, cable support system	Click fastening