

Technical data sheet

90° Magic bend 85 FT

Item number: 6041514



90° bend with quick connector system. For all cable tray types of 85 mm side height.

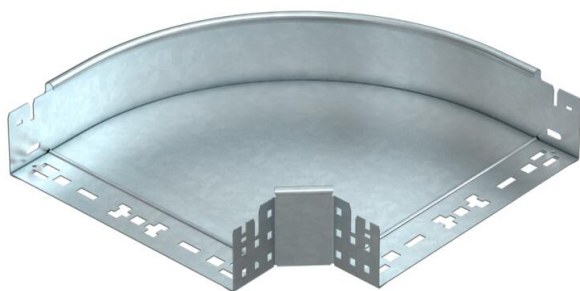

St Steel

FT Hot-dip galvanised

Master data

Item number	6041514
Type	RBM 90 830 FT
Description 1	90° bend
Description 2	with quick connector
Manufacturer	OBO
Dimension	85x300
Material	Steel
Surface	Hot-dip galvanised
Surface standard	DIN EN ISO 1461
Smallest sales unit	1
Unit of quantity	Piece
Weight	228.7 kg
Weight unit	kg/100 pc.

Technical data sheet

90° Magic bend 85 FT

Item number: 6041514



Dimensions

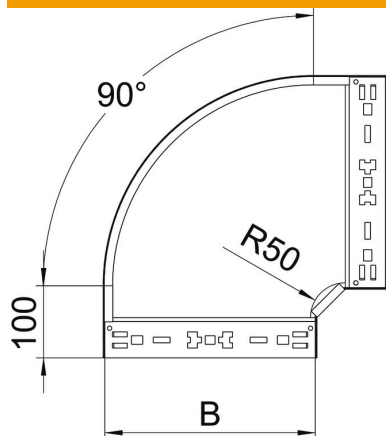

Width	300 mm
Height	85 mm
Plate thickness	1.25 mm
Dimension B	300 mm

Technical data

Bend (angle)	90°
Connector version	Integrated connector
Maintain electrical functions	no
Mounting perforation in base	no
NATO hole pattern	no
Change of direction	Horizontal
Rustproof steel, pickled	no
Side perforation	no
Wide-span version	no
Type of connector, cable support system	Click fastening