

Technical data sheet

90° Magic bend 85 FS

Item number: 6041496



90° bend with quick connector system. For all cable tray types of 85 mm side height.



St Steel

FS Strip galvanized

Master data

Item number	6041496
Type	RBM 90 840 FS
Description 1	90° bend
Description 2	with quick connector
Manufacturer	OBO
Dimension	85x400
Material	Steel
Surface	Strip galvanized
Surface standard	DIN EN 10346
Smallest sales unit	1
Unit of quantity	Piece
Weight	299.7 kg
Weight unit	kg/100 pc.

Technical data sheet

90° Magic bend 85 FS

Item number: 6041496



Dimensions

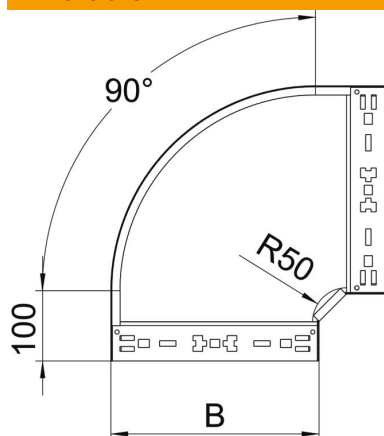

Width	400 mm
Height	85 mm
Plate thickness	1.25 mm
Dimension B	400 mm

Technical data

Bend (angle)	90°
Connector version	Integrated connector
Maintain electrical functions	no
Mounting perforation in base	no
NATO hole pattern	no
Change of direction	Horizontal
Rustproof steel, pickled	no
Side perforation	no
Wide-span version	no
Type of connector, cable support system	Click fastening