

# Technical data sheet

90° bend 60 A4

Item number: 7134292



90° bend, horizontal and unperforated, for all cable tray types of 60 mm side height.  
Fitting, unperforated, in round design. The interior radius of the fitting is 150 mm.  
Fastening materials should be ordered separately.



**A4** Stainless steel

**2B** Bright, treated

## Master data

Item number	7134292
Type	RBU 90 640 A4
Description 1	90° bend
Description 2	unperforated, round type
Manufacturer	OBO
Dimension	60x400
Material	Stainless steel
Surface	Bright, treated
Surface standard	
Smallest sales unit	1
Unit of quantity	Piece
Weight	465 kg
Weight unit	kg/100 pc.

## Dimensions

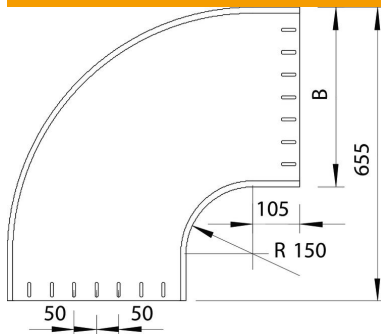

Width	400 mm
Width	16 in
Height	60 mm
Height	2 in
Plate thickness	1.5 mm
Dimension B	400 mm
Dimension R	150 mm

# Technical data sheet

90° bend 60 A4

Item number: 7134292



## Technical data

Bend (angle)	90°
Connector version	Without connectors
Change of direction	Horizontal
Type of connector, cable support system	Screwed