

Technical data sheet

110 FT cross-over

Item number: 7115113

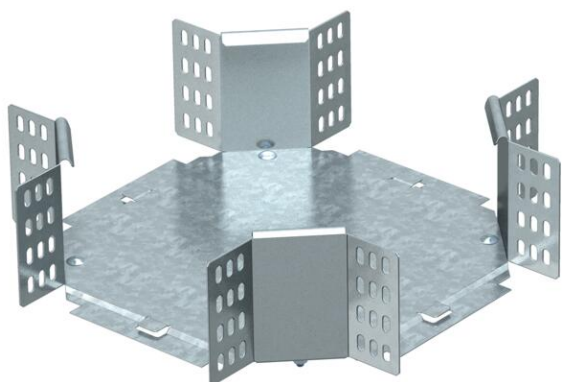

Horizontal cross-over for all cable tray types of 110 mm side height.
The fitting is shipped in an unmounted state. Including appropriate fastening material.



St Steel

FT Hot-dip galvanised

Master data

Item number	7115113
Type	RK 110 FT
Description 1	Cross over
Description 2	horizontal + angle connector
Manufacturer	OBO
Dimension	110x100
Material	Steel
Surface	Hot-dip galvanised
Surface standard	DIN EN ISO 1461
Smallest sales unit	1
Unit of quantity	Piece
Weight	120 kg
Weight unit	kg/100 pc.

Technical data sheet

110 FT cross-over

Item number: 7115113



Dimensions

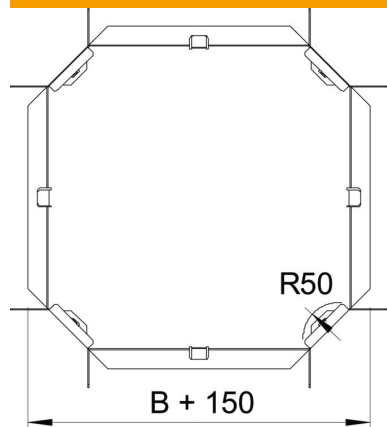

Width	100 mm
Width	4 in
Height	110 mm
Height	4 in
Dimension B	100 mm
Dimension R	50 mm

Technical data

Bend (angle)	90°
Connector version	Supplied connectors
Maintain electrical functions	no
Material thickness, floor plate	1 mm
Change of direction	Horizontal
Rustproof steel, pickled	no
Wide-span version	no
Type of connector, cable support system	Screwed
Rail thickness	1.25 mm