

Technical data sheet

Cross-over 60 FT

Item number: 7113110

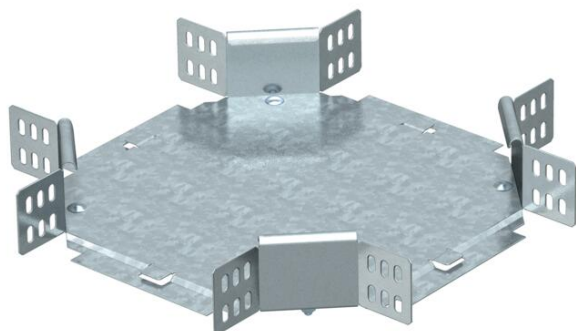

Horizontal cross-over for all cable tray types of 60 mm side height.
The fitting is shipped in an unmounted state. All the sides are designed for the same cable tray width.
Including appropriate fastening material.



- St** Steel
- FT** Hot-dip galvanised

Master data

Item number	7113110
Type	RK 610 FT
Description 1	Cross over
Description 2	horizontal + angle connector
Manufacturer	OBO
Dimension	60x100
Material	Steel
Surface	Hot-dip galvanised
Surface standard	DIN EN ISO 1461
Smallest sales unit	1
Unit of quantity	Piece
Weight	97 kg
Weight unit	kg/100 pc.

Technical data sheet

Cross-over 60 FT

Item number: 7113110



Dimensions

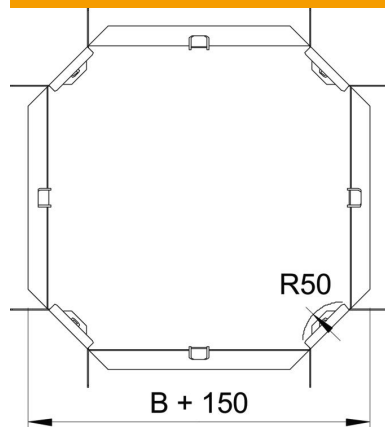

Width	100 mm
Width	4 in
Height	60 mm
Height	2 in
Dimension B	100 mm
Dimension R	50 mm

Technical data

Bend (angle)	90°
Connector version	Supplied connectors
Maintain electrical functions	no
Material thickness, floor plate	1 mm
Change of direction	Horizontal
Rustproof steel, pickled	no
Wide-span version	no
Type of connector, cable support system	Screwed
Rail thickness	1.25 mm