

# Technical data sheet

## Reducer / stop-end DD

Item number: 7107331



Reducer/stop-end for cable trays with side height 85 mm.  
From a width of 150 mm, a perforated bottom flange is available.

Including appropriate fastening material.

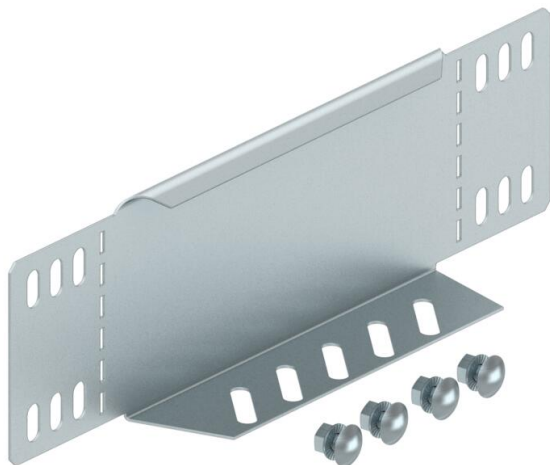

**St** Steel

**DD** Strip galvanised zinc/aluminium, Double Dip

### Master data

Item number	7107331
Type	RWEB 820 DD
Description 1	Reducer profile/end closure
Description 2	for cable tray
Manufacturer	OBO
Dimension	85x200
Material	Steel
Surface	Strip galvanised zinc/aluminium, Double Dip
Surface standard	DIN EN 10346
Smallest sales unit	1
Unit of quantity	Piece
Weight	23 kg
Weight unit	kg/100 pc.

# Technical data sheet

Reducer / stop-end DD

Item number: 7107331



## Dimensions

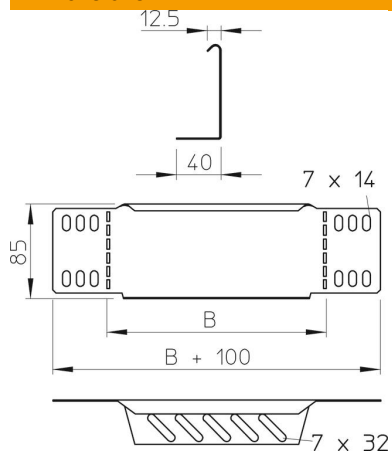

Width	200 mm
Width	8 in
Height	85 mm
Height	3 in
Plate thickness	1 mm
Dimension B	200 mm

## Technical data

Maintain electrical functions	no
Rustproof steel, pickled	no