

Technical data sheet

Aluminium pipe bend, with thread

Item number: 2046042



90° bend for electrical installation pipes according to EN 61386-1 with threaded ends to DIN EN 60423. With burr-free inner wall.
One connection sleeve is already screwed onto each pipe bend.



Alu Aluminium

Master data

Item number	2046042
Type	SBM16W ALU
Description 1	Aluminium conduit bend
Description 2	with thread
Manufacturer	OBO
Dimension	M16x1,5
Material	Aluminium
Smallest sales unit	15
Unit of quantity	Piece
Weight	3.3 kg
Weight unit	kg/100 pc.

Technical data sheet

Aluminium pipe bend, with thread

Item number: 2046042



Dimensions

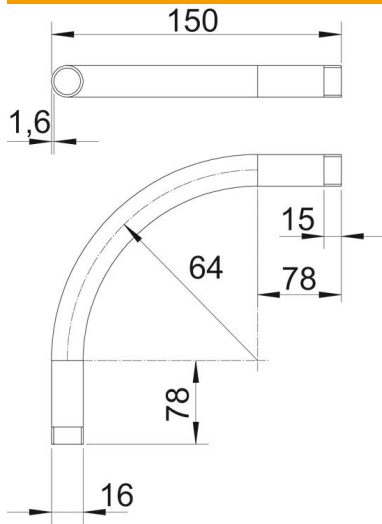

Dimension A	78 mm
Dimension B	150 mm
Dimension D	16 mm
Dimension I	15 mm
Dimension m (mm)	M16
Dimension R	64 mm
Dimension t	1.6 mm

Technical data

Version for	Thread
Flexible	no
For nominal pipe diameter	16 mm
Thread	M16x1,5
Halogen-free	no
With inspection opening and lid	no
With sleeve	yes
Brushed surface	no
Polished surface	no
Permitted temperature range, max.	250 °C
Permitted temperature range, min.	-45 °C
Angle of the bend	90 °
Two-part	no