

# Technical data sheet

## Adjustable bend element 110 FT

Item number: 6225548



Adjustable bend element, heavy-duty, with welded rung for use in the cable ladder types with a side height of 110 mm.



**St** Steel

**FT** Hot-dip galvanised

### Master data

Item number	6225548
Type	SLGBE 11100 FT
Description 1	Adjustable bend element
Description 2	for cable ladder
Manufacturer	OBO
Dimension	110x1000
Material	Steel
Surface	Hot-dip galvanised
Surface standard	DIN EN ISO 1461
Smallest sales unit	1
Unit of quantity	Piece
Weight	324.4 kg
Weight unit	kg/100 pc.

# Technical data sheet

## Adjustable bend element 110 FT

Item number: 6225548



### Dimensions

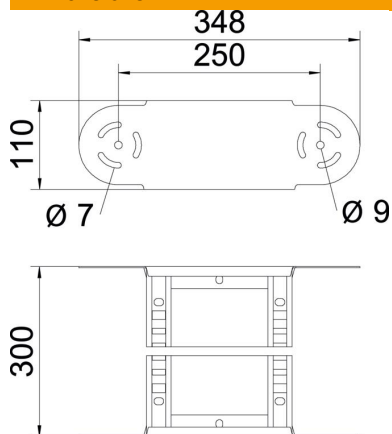

Width	1,000 mm
Height	110 mm
Dimension B	1,000 mm
Dimension R	1,000 mm

### Technical data

Bend (angle)	Adjustable
Version of the rungs	Profile perforated
Side rail version	Flat profile
Connector version	Integrated connector
Maintain electrical functions	no
Change of direction	Vertical, rising/falling
Rustproof steel, pickled	no
Hinged	yes
Side perforation	no
Wide-span version	no
Rail thickness	2 mm