

# Technical data sheet

## SLL 60 medium-duty vertical ladder, 6 m, FT

Item number: 6010636



Vertical ladder with a side height of 60 mm with riveted C profile rungs, open in upwards direction.  
Fastening takes place directly on the wall or using the wall brackets, type WB 30/75. The slot dimension of the rung is 18 mm and the appropriate clamp clip is type 2056U.



- St** Steel
- FT** Hot-dip galvanised

### Master data

Item number	6010636
Type	SLL 650 CPS 4 FT
Description 1	Medium duty vertical ladder
Description 2	with CPS rung
Manufacturer	OBO
Dimension	60x500x6000
Material	Steel
Surface	Hot-dip galvanised
Surface standard	DIN EN ISO 1461
Smallest sales unit	6
Unit of quantity	Metre
Weight	374.6 kg
Weight unit	kg/100 m

# Technical data sheet

SLL 60 medium-duty vertical ladder, 6 m, FT

Item number: 6010636



## Dimensions

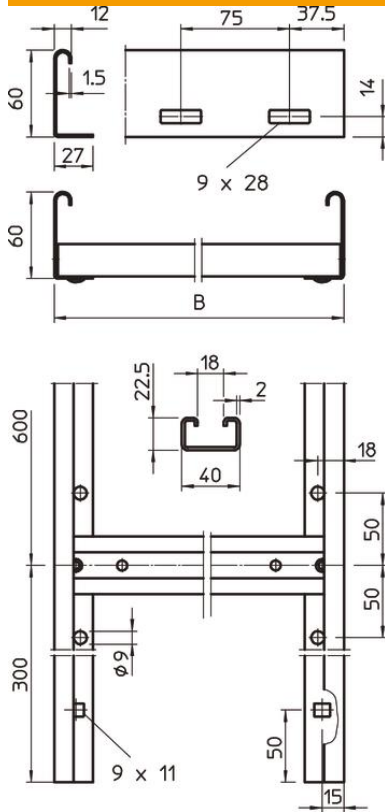

Length	6,000 mm
Width	500 mm
Height	60 mm
Dimension B	500 mm
Rung slot dimension	18.00

## Technical data

Side wall version	Flat profile
Version of the rungs	Profile perforated
Maintain electrical functions	no
Usable cross-section	190 cm <sup>2</sup>
Rustproof steel, pickled	no
Side perforation	yes
Rung distance	600 mm
Rail thickness	1.5 mm