

Technical data sheet

External corner SLL AE2070

Item number: 6132262



External corner as a fitting for changing the direction of the skirting trunking.
External corner for snapping on to the base to conceal cuts.



PVC Polyvinylchloride

Master data

Item number	6132262
Type	SLL AE2070 rws
Description 1	External corner
Description 2	SL-L 20x70 9010
Manufacturer	OBO
Colour	Pure white; RAL 9010
Material	Polyvinylchloride
Smallest sales unit	10
Unit of quantity	Piece
Weight	1.75 kg
Weight unit	kg/100 pc.

Technical data sheet

External corner SLL AE2070

Item number: 6132262

Dimensions

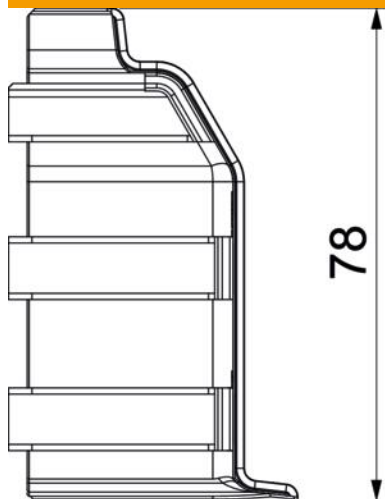

Length	78 mm
Height	46 mm

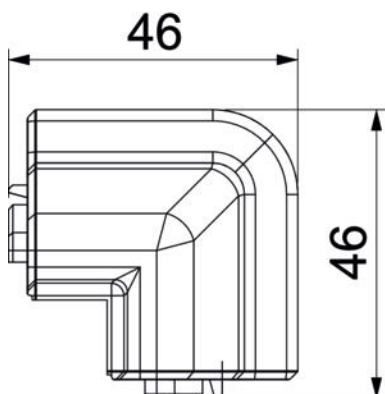

Technical data

Version for	Hood fitting
Decoration	Without
Cover sealing lip	Wall/floor
Halogen-free	no
With carpet strip	no
Protection rating	IP40
Protection rating IK code	IK06
Permitted temperature range, max.	60 °C
Permitted temperature range, min.	-5 °C
Angle range, min.	90 mm