

Technical data sheet

Cable ladder with trapezoidal rungs, light duty A4

Item number: 7099712



Shipbuilding cable ladder with perforated side rail of side height 25 mm with welded, perforated trapezoidal rungs which open in a downwards direction. Load tested according to IEC in conjunction with connector, type SLV. The shipbuilding cable ladder is also available in unpainted steel on request.



A4 Stainless steel

2B Bright, treated

Master data

Item number	7099712
Type	SL 42 300 A4
Description 1	Cable ladder, shipbuilding
Description 2	with trapezoidal rung
Manufacturer	OBO
Dimension	25x306x2000
Material	Stainless steel
Surface	Bright, treated
Surface standard	
Smallest sales unit	2
Unit of quantity	Metre
Weight	140.8 kg
Weight unit	kg/100 m

Technical data sheet

Cable ladder with trapezoidal rungs, light duty A4

Item number: 7099712



Dimensions

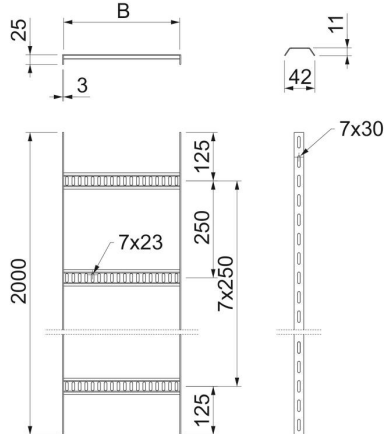

Length	2,000 mm
Length	2,000 ft
Width	306 mm
Height	25 mm
Dimension B	306 mm

Technical data

Version of the rungs	Profile perforated
Side rail version	Flat profile
Fastening of rung	Welded
Maintain electrical functions	no
Rustproof steel, pickled	yes
Side perforation	yes
Rung distance	250 mm
Wide-span version	no
Rail thickness	3 mm

Loads

Support spacing 1.0 m	1.45 kN/m
Support spacing 1.5 m	0.65 kN/m
Support spacing 2.0 m	0.25 kN/m

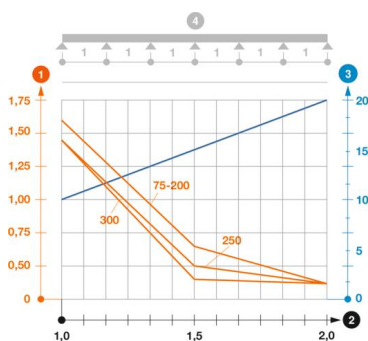

Load diagram, cable ladder, type SL 42

- 1 Permitted cable tray/ladder load in kN/m without man load
- 2 Support width in m
- 3 Rail bend in mm at permitted kN/m
- Load curve with cable tray/ladder width in mm
- Strut bend curve according to support width
- 4 Load scheme during testing