

Technical data sheet

Cable ladder with trapezoidal rungs, standard A2

Item number: 7097096



Shipbuilding cable ladder with perforated side rail of side height 40 mm with welded, perforated trapezoidal rungs which open in a downwards direction. Load tested according to IEC in conjunction with connector, type SLV. The shipping cable ladder is also available in unpainted steel on request.



A2 Stainless steel

2B Bright, treated

Master data

Item number	7097096
Type	SL 62 200 A2
Description 1	Cable ladder, shipbuilding
Description 2	with trapezoidal rung
Manufacturer	OBO
Dimension	40x210x3000
Material	Stainless steel
Surface	Bright, treated
Surface standard	
Smallest sales unit	3
Unit of quantity	Metre
Weight	332.334 kg
Weight unit	kg/100 m

Technical data sheet

Cable ladder with trapezoidal rungs, standard A2

Item number: 7097096



Dimensions

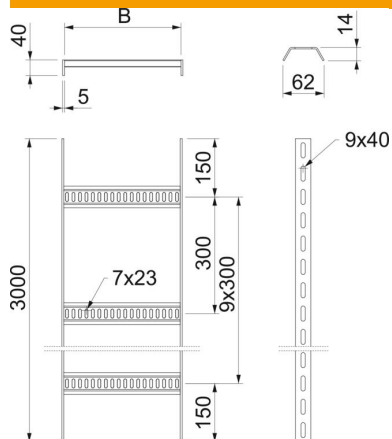

Dimension	40 X 210
Length	3,000 mm
Length	3,000 ft
Width	200 mm
Height	40 mm
Dimension B	210 mm

Technical data

Version of the rungs	Profile perforated
Side rail version	Flat profile
Fastening of rung	Welded
Maintain electrical functions	no
Rustproof steel, pickled	yes
Side perforation	yes
Rung distance	300 mm
Wide-span version	no
Rail thickness	5 mm

Loads

Support spacing 1.5 m	2.8 kN/m
Support spacing 2.0 m	1.2 kN/m
Support spacing 2.5 m	0.8 kN/m
Support spacing 3.0 m	0.45 kN/m

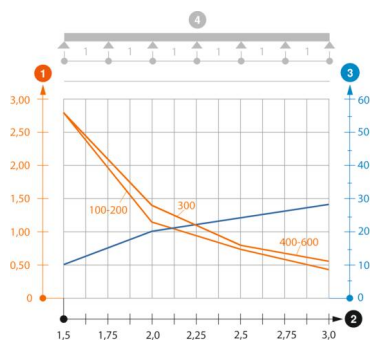

Load diagram, cable ladder, type SL62 A2 A4

- 1 Permitted cable tray/ladder load in kN/m without man load
- 2 Support width in m
- 3 Rail bend in mm at permitted kN/m
- Load curve with cable tray/ladder width in mm
- Strut bend curve according to support width
- 4 Load scheme during testing