

# Technical data sheet

External corner SL AE2070

Item number: 6132272



External corner as a fitting for changing the direction of the skirting trunking.  
External corner for snapping on to the base to conceal cuts.



**PVC** Polyvinylchloride

## Master data

Item number	6132272
Type	SL AE2070 lgr
Description 1	External corner
Description 2	SL 20x70 7035
Manufacturer	OBO
Colour	Light grey; RAL 7035
Material	Polyvinylchloride
Smallest sales unit	10
Unit of quantity	Piece
Weight	1.53 kg
Weight unit	kg/100 pc.

# Technical data sheet

## External corner SL AE2070

Item number: 6132272



### Dimensions

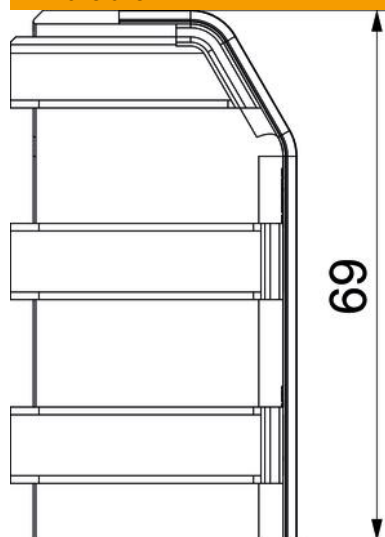

Length	37 mm
Height	69 mm

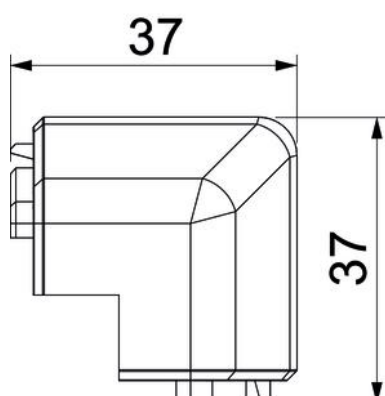

### Technical data

Version for	Hood fitting
Decoration	Without
Cover sealing lip	Without
Halogen-free	no
With carpet strip	no
Protection rating	IP40
Protection rating IK code	IK06
Permitted temperature range, max.	60 °C
Permitted temperature range, min.	-5 °C
Angle range, min.	90 mm