

Technical data sheet

Closed FireBox T250, empty

Item number: 7205784

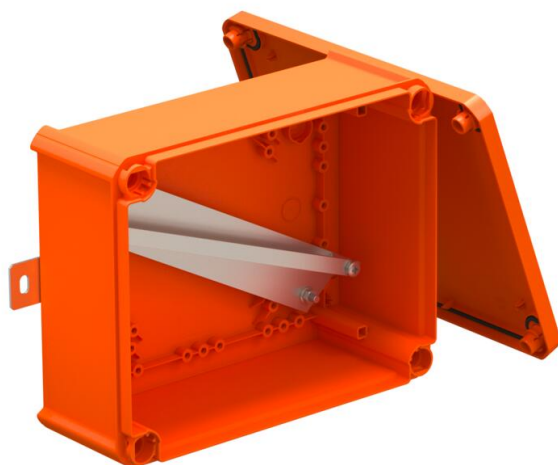

Unequipped, closed connection or junction box for free termination with ceramic terminals and cable glands. Dimension A states the available support rail length for the wiring terminals. Sufficiently large wiring compartment through diagonally arranged support rail. Fastening on easily accessible external flaps made of stainless steel. Approved for cable systems that maintain the electrical function according to DIN 4102 Part 12 with the classes E30, E60 and E90.

E30 E60 E90 IP 66

PP Polypropylene

Master data

Item number	7205784
Type	T250E 0VA
Description 1	Junction box
Description 2	for function maintenance
Manufacturer	OBO
Dimension	240x190x95
Colour	Pastel orange; RAL 2003
Material	Polypropylene
Smallest sales unit	1
Unit of quantity	Piece
Weight	74.084 kg
Weight unit	kg/100 pc.

Technical data sheet

Closed FireBox T250, empty

Item number: 7205784

Dimensions

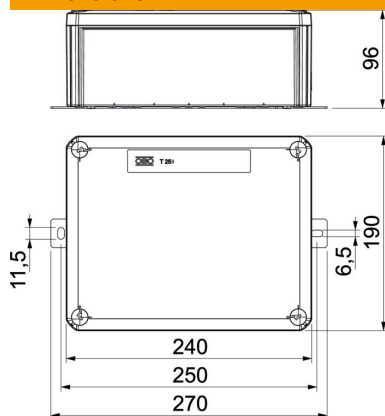

Length	240 mm
Width	190 mm
Height	95 mm
Dimension A	286 mm
Dimension B	190 mm
Dimension H	95 mm
Dimension L	240 mm
Dimension L1	250 mm
Dimension L2	270 mm

Technical data

Equipment	Support rail
Cover	Not transparent
Cover fastening	Screwed
Entry from rear	no
Maintain electrical functions	E 90
Halogen-free	yes
Clear internal dimensions	225x173x86 mm
With screening	no
with lid	yes
Nominal cross-section, max.	16 mm ²
Nominal cross-section, min.	0.5 mm ²
Sealable	no
Protection rating	IP66