

Technical data sheet

Chuck jaw, light-duty TKS A4

Item number: 6355835



Chuck jaw with hexagonal nut for direct fastening of structures to steel girders. The clamping range of the chuck jaw is limited to the maximum fastening thickness of 36 mm.



A4 Stainless steel

Master data

Item number	6355835
Type	TKS-L36 M8 A4
Description 1	Tensioning claw, light
Manufacturer	OBO
Dimension	M8x80
Material	Stainless steel
Smallest sales unit	1
Unit of quantity	Piece
Weight	16 kg
Weight unit	kg/100 pc.

Technical data sheet

Chuck jaw, light-duty TKS A4

Item number: 6355835



Dimensions

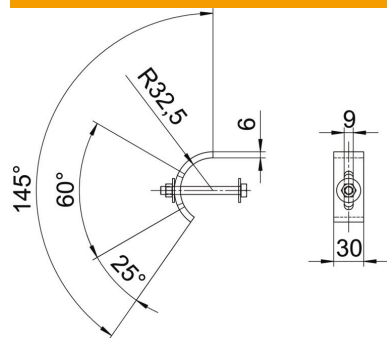

Height	36 mm
--------	-------

Technical data

F in kN	10 kN
Suitable for flange thickness, max.	36 mm
Suitable for flange thickness, min.	16 mm
Thread metric	8
Bolt	M8 x 80