

Technical data sheet

US 5 support A2

Item number: 6341386



Suspended support (U profile) with welded head plate.
For fastening to horizontal concrete ceilings and steel girders. For bracket widths of 400 mm or more, or if the bracket is mounted at the end of a suspended support, we recommend the use of the spacer, type DSK 45.



A2 Stainless steel

2B Bright, treated

Master data

Item number	6341386
Type	US 5 K 90 A2
Description 1	Support
Description 2	with welded head plate
Manufacturer	OBO
Dimension	50x50x900
Material	Stainless steel
Surface	Bright, treated
Surface standard	
Smallest sales unit	1
Unit of quantity	Piece
Weight	280 kg
Weight unit	kg/100 pc.

Technical data sheet

US 5 support A2

Item number: 6341386



Dimensions

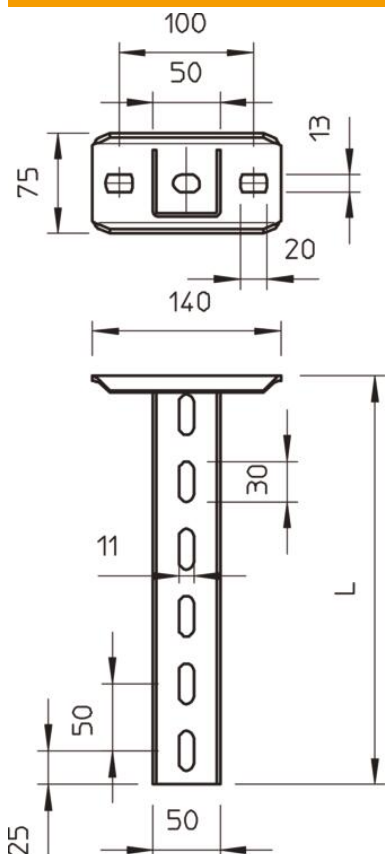

Length	900 mm
Width	50 mm
Height	50 mm

Loads



Chara

Max. total
= 10 cm
of ETA(a)

Technical data

Version for	U profile
Bracket length 200	5.75 kN
Bracket length 400	3.1 kN
Bracket length 600	2.2 kN
Maintain electrical functions	no
Material thickness	2.5 mm
Maximum tensile load	10 kN