

Technical data sheet

90° bend 160 FS

Item number: 6098707



90° bend, horizontal, for all wide span cable trays of 160 mm side height.
For further stabilisation, additional supports should be planned for the area of the fittings.



St Steel

FS Strip galvanized

Master data

Item number	6098707
Type	WRB 90 163 FS
Description 1	90° bend
Description 2	for wide span cable tray 160
Manufacturer	OBO
Dimension	160x300
Material	Steel
Surface	Strip galvanized
Surface standard	DIN EN 10346
Smallest sales unit	1
Unit of quantity	Piece
Weight	1664 kg
Weight unit	kg/100 pc.

Dimensions

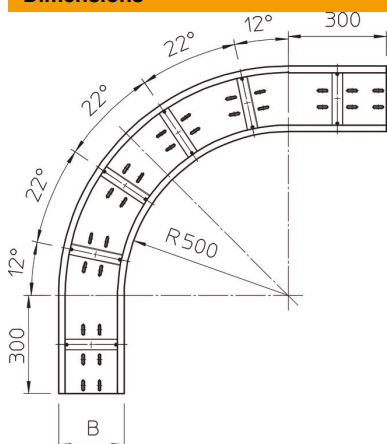

Width	300 mm
Height	160 mm
Plate thickness	2 mm
Dimension B	300 mm

Technical data sheet

90° bend 160 FS

Item number: 6098707



Technical data

Bend (angle)	90°
Connector version	Without connectors
Mounting perforation in base	yes
Change of direction	Horizontal
Rustproof steel, pickled	no
Side perforation	no
Wide-span version	yes
Type of connector, cable support system	Screwed