

Technical data sheet

Rung WSK 40

Item number: 6008054



Angle profile rungs for use in heavy-duty vertical ladders and in IS 8 supports.
The maximum rung load is 250 kg.

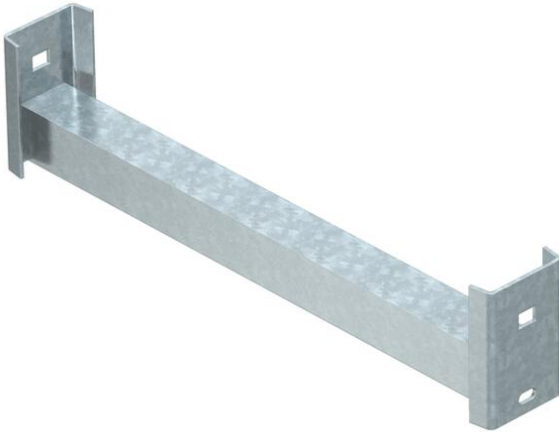

St Steel

FT Hot-dip galvanised

Master data

Item number	6008054
Type	WSK 40 50 FT
Description 1	Angle rung
Description 2	for IS 8 support
Manufacturer	OBO
Dimension	B454mm
Material	Steel
Surface	Hot-dip galvanised
Surface standard	DIN EN ISO 1461
Smallest sales unit	1
Unit of quantity	Piece
Weight	147 kg
Weight unit	kg/100 pc.

Technical data sheet

Rung WSK 40

Item number: 6008054



Dimensions

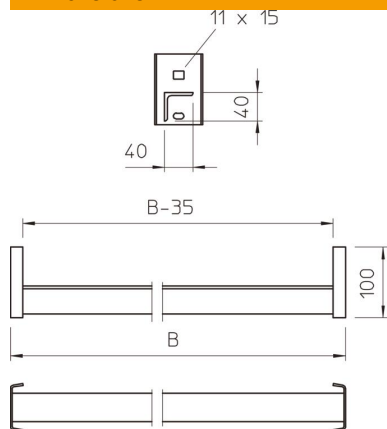

lampDimension WxH	40 x 40 mm
Length	454 mm
Width	454 mm
Height	100 mm

Technical data

Material thickness	4 mm
--------------------	------