

Fijación a Viga

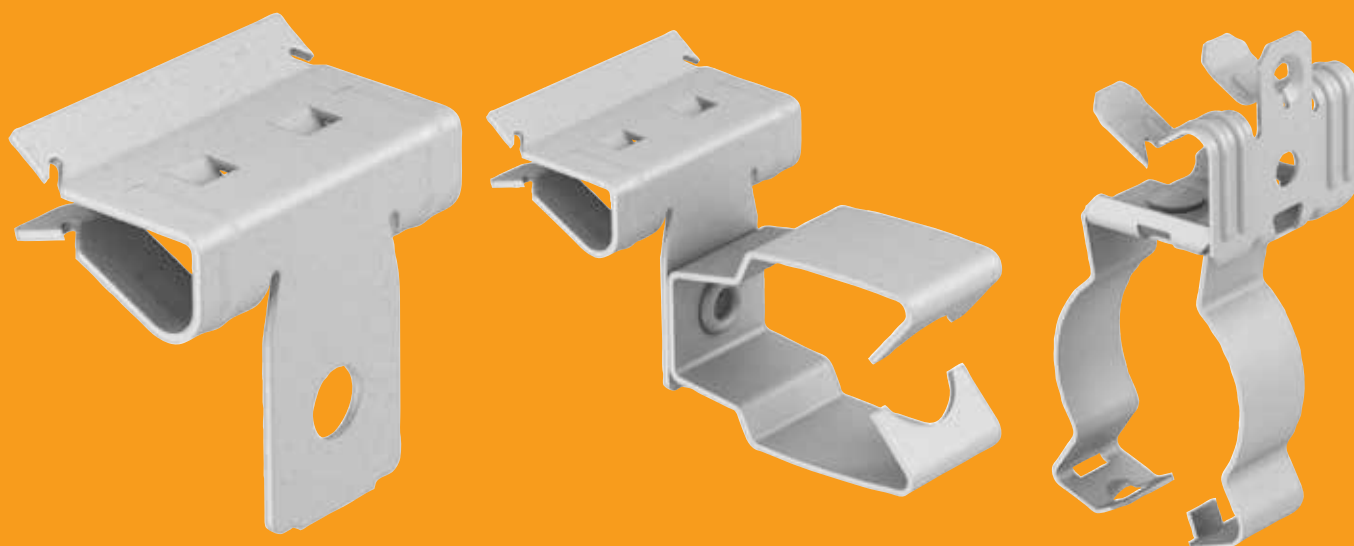

VBS Sistemas de Fijación

OBO
BETTERMANN

Fijación a Viga, guía de instalación

La fijación a viga permite instalar componentes adicionales en la parte inferior de diferentes tipos de estructuras de vigas de acero. Para ello es importante tener en cuenta los rangos de apriete o el espesor de cada viga o pletina metálica. El rango de la fijación a viga y el tipo de sujeción, por impacto o rosca, permite varias aplicaciones por ejemplo de cadenas de suspensión o tubo. Las fijaciones por impacto encajan en el patín de la viga o en la pletina y se agarran con una fuerza de apriete que ha sido incrementada en los nuevos modelos, mejorando su funcionalidad técnica.



Fácil colocación

La fijación a viga se coloca en esta y con un suave golpe se inserta en el patín de la viga o pletina.



Versatilidad de uso

Portfolio completo con cadenas de suspensión para lámparas con sus correspondiente elementos.



Montajes rápidos

Ejemplo de montaje con abrazadera de tornillo 732 de OBO para instalación de tubo pasacable.



Fijación para varillas roscadas

Ejemplo de una fijación a viga para soportar carga mediante una varilla roscada con manguito de unión.









Fijación para tubo paralelo





Ejemplo de instalación de tubo paralelo a la viga con abrazadera plástica Quick de OBO.



Fijación para tubo sobre viga

Ejemplo de instalación del tubo sobre la viga con fijación tipo clip.

	Nuevo					Alt		
	Código	Tipo	Espesor Viga	D máx. Ø	Emb. Unidad	Código	Tipo	Espesor Viga
	1483601	BCVH 2-4	2-4mm		100	1480400	TKN 4-0	2-4mm
	1483603	BCVH 4-8	4-8mm		100	1480404	TKN 9-0	5-9mm
	1483605	BCVH 8-14	8-14mm		100	1480408	TKN 16-0	10-16mm
	1483607	BCVH 14-20	14-20mm		100	1480412	TKN 20-0	17-20mm
	1483611	BCVTB 2-4 M6	2-4mm		100	1481102	TK-G 4	2-4mm
	1483613	BCVTB 4-8 M6	4-8mm		100	1481108	TK-G 9	5-9mm
	1483615	BCVTB 8-14 M6	8-14mm		100	1481114	TK-G 16	10-16mm
	1483617	BCVTB 14-20 M6	14-20mm		100	1481120	TK-G 20	17-20mm
	1483621	BCUIT 3-7 M6	3-7mm		100	1480430	TKIN 7-6	3-7mm
	1483623	BCUIT 8-12,5 M6	8-12,5mm		100	1480434	TKIN 12,5-6	8-12,5mm
	1483625	BCUIT 14-20 M6	14-20mm		100	1480438	TKIN 20-6	14-20mm
	1483631	BCUTB 3-7 M6	3-7mm		100	1480450	TKGN 7-6	3-7mm
	1483633	BCUTB 8-12,5 M6	8-12,5mm		100	1480454	TKGN 12,5-6	8-12,5mm
	1483635	BCUTB 14-20 M6	14-20mm		100	1480458	TKGN 20-6	14-20mm
	1483641	BCCT 2-4 L240	2-4mm	-70mm	50	1480470	TKKN 4-240	2-4mm
	1483643	BCCT 4-8 L240	4-8mm	-70mm	50	1480478	TKKN 9-240	5-9mm
	1483645	BCCT 4-8 L365	4-8mm	-110mm	50	1480482	TKKN 9-365	5-9mm
	1483647	BCCT 8-14 L240	8-14mm	-70mm	50	1480486	TKKN 16-240	10-16mm
	1483649	BCCT 8-14 L365	8-14mm	-110mm	50	1480490	TKKN 16-365	10-16mm
	1483651	BCCT 14-20 L240	14-20mm	-70mm	50	1480494	TKKN 20-240	17-20mm
	1483653	BCCT 14-20 L365	14-20mm	-110mm	50			
	1483661	BCTR 4-8 M6	4-8mm		50	1480522	TKRN 9-6	5-9mm
	1483663	BCTR 8-14 M6	8-14mm		50	1480526	TKRN 16-6	10-16mm
	1483665	BCTR 4-8 M8	4-8mm		50	1480530	TKRN 9-8	5-9mm
	1483667	BCTR 8-14 M8	8-14mm		50	1480534	TKRN 16-8	10-16mm
	1483669	BCTR 4-8 M10	4-8mm		50	1480538	TKRN 9-10	5-9mm
	1483671	BCTR 8-14 M10	8-14mm		50	1480542	TKRN 16-10	10-16mm
	1483681	BCHPC 2-4 D20	2-4mm	18-24mm	50	1480570	TKSN 4-25	2-4mm
	1483683	BCHPC 2-4 D25	2-4mm	22-26mm	50			
	1483685	BCHPC 2-4 D32	2-4mm	30-32mm	50	1480578	TKSN 4-40	2-4mm
	1483687	BCHPC 4-8 D20	4-8mm	18-24mm	50	1480582	TKSN 9-25	5-9mm
	1483689	BCHPC 4-8 D25	4-8mm	22-26mm	50			
	1483691	BCHPC 4-8 D32	4-8mm	30-32mm	50	1480590	TKSN 9-32	5-9mm
	1483693	BCHPC 4-8 D40	4-8mm	36-40mm	50			
	1483701	BCHPC 8-14 D20	8-14mm	18-24mm	50	1480586	TKSN 16-25	10-16mm
	1483703	BCHPC 8-14 D25	8-14mm	22-26mm	50			
	1483705	BCHPC 8-14 D32	8-14mm	30-32mm	50	1480594	TKSN 16-32	10-16mm
	1483707	BCHPC 8-14 D40	8-14mm	36-40mm	50	1480602	TKSN 16-40	10-16mm
	1483711	BCHPC 14-20 D20	14-20mm	18-24mm	50	1480606	TKSN 20-25	17-20mm
1483713	BCHPC 14-20 D25	14-20mm	22-26mm	50				
1483715	BCHPC 14-20 D32	14-20mm	30-32mm	50	1480610	TKSN 20-32	17-20mm	
1483717	BCHPC 14-20 D40	14-20mm	36-40mm	50	1480614	TKSN 20-40	17-20mm	

	Nuevo					Alt		
	Código	Tipo	Espesor Viga	D máx. Ø	Emb. Unidad	Código	Tipo	Espesor Viga
	1483811	BCHPO 2-4 D20	2-4mm	20mm	50	1480630	TKCN 4-20	2-4mm
	1483813	BCHPO 2-4 D25	2-4mm	25mm	50	1480634	TKCN 4-25	2-4mm
	1483815	BCHPO 2-4 D32	2-4mm	32mm	50			
	1483821	BCHPO 4-8 D20	4-8mm	20mm	50	1480638	TKCN 9-20	5-9mm
	1483831	BCHPO 8-14 D20	8-14mm	25mm	50	1480642	TKCN 16-20	10-16mm
	1483823	BCHPO 4-8 D25	4-8mm	32mm	50	1480646	TKCN 9-25	5-9mm
	1483833	BCHPO 8-14 D25	8-14mm	20mm	50	1480650	TKCN 16-25	10-16mm
	1483825	BCHPO 4-8 D32	4-8mm	25mm	50	1480654	TKCN 9-32	5-9mm
	1483835	BCHPO 8-14 D32	8-14mm	32mm	50	1480658	TKCN 16-32	10-16mm
	1483841	BCHPO 14-20 D20	14-20mm	20mm	50	1480662	TKCN 20-20	17-20mm
	1483843	BCHPO 14-20 D25	14-20mm	25mm	50	1480666	TKCN 20-25	17-20mm
	1483845	BCHPO 14-20 D32	14-20mm	32mm	50	1480670	TKCN 20-32	17-20mm
	1483751	BCVPO 3-7 D20	3-7mm	20mm	50	1480710	TKCUN 7-20	3-7mm
	1483753	BCVPO 3-7 D25	3-7mm	25mm	50	1480714	TKCUN 7-25	3-7mm
	1483757	BCVPO 3-7 D32	3-7mm	32mm	50			
	1483761	BCVPO 8-12,5 D20	8-12,5mm	20mm	50	1480722	TKCUN 12,5-20	8-12,5mm
	1483763	BCVPO 8-12,5 D25	8-12,5mm	25mm	50	1480726	TKCUN 12,5-25	8-12,5mm
	1483765	BCVPO 8-12,5 D32	8-12,5mm	32mm	50	1480730	TKCUN 12,5-32	8-12,5mm
	1483771	BCVPO 14-20 D20	14-20mm	20mm	50			
	1483773	BCVPO 14-20 D25	14-20mm	25mm	50	1480738	TKCUN 20-25	14-20mm
1483775	BCVPO 14-20 D32	14-20mm	32mm	50	1480742	TKCUN 20-32	14-20mm	
	1483781	BCVPC 3-7 D20	3-7mm	19-22mm	50	1480760	TKSUN 7-25	3-7mm
	1483783	BCVPC 3-7 D25	3-7mm	23-25mm	50			
	1483785	BCVPC 3-7 D32	3-7mm	26-32mm	50			
	1483787	BCVPC 3-7 D40	3-7mm	33-40mm	50	1480768	TKSUN 7-40	3-7mm
	1483791	BCVPC 8-12,5 D20	8-12,5mm	19-22mm	50	1480772	TKSUN 12,5-25	8-12,5mm
	1483793	BCVPC 8-12,5 D25	8-12,5mm	23-25mm	50			
	1483795	BCVPC 8-12,5 D32	8-12,5mm	26-32mm	50	1480776	TKSUN 12,5-32	8-12,5mm
	1483797	BCVPC 8-12,5 D40	8-12,5mm	33-40mm	50	1480780	TKSUN 12,5-40	8-12,5mm
	1483801	BCVPC 14-20 D20	14-20mm	19-22mm	50	1480784	TKSUN 20-25	14-20mm
	1483803	BCVPC 14-20 D25	14-20mm	23-25mm	50			
	1483805	BCVPC 14-20 D32	14-20mm	26-32mm	50	1480788	TKSUN 20-32	14-20mm
	1483807	BCVPC 14-20 D40	14-20mm	33-40mm	50	1480792	TKSUN 20-40	14-20mm
	1483991	CPC M6x9	M6x9mm		100	1486608	TKD 9	M6x9mm
	1483993	CPC M6x16	M6x16mm		100	1486616	TKD 16	M6x-16mm
	1483995	CPC M6x25	M6x25mm		100	1486624	TKD 25	M6x-25mm
	1483997	CPCN M6	M6		100	1486675	TKD G	M6

	Nuevo					Alt		
	Código	Tipo	Espesor Viga	D máx. Ø	Emb. Unidad	Código	Tipo	Espesor Viga
	1483901	BCC 2-4 D5,5	2-4mm	4,5-5,5mm	100	1487500	TKCI 4-5 N	2-4mm
	1483903	BCC 2-4 D7	2-4mm	6-7mm	100	1487502	TKCI 4-7 N	2-4mm
	1483905	BCC 2-4 D9	2-4mm	7-9mm	100	1487504	TKCI 4-9 N	2-4mm
	1483907	BCC 2-4 D11	2-4mm	10-11mm	100	1487506	TKCI 4-12 N	2-4mm
	1483911	BCC 2-4 D14	2-4mm	12-14mm	100	1487508	TKCI 4-14 N	2-4mm
	1483915	BCC 2-4 D18	2-4mm	15-18mm	100	1487510	TKCI 4-18 N	2-4mm
	1483919	BCC 2-4 D24	2-4mm	19-24mm	100	1487512	TKCI 4-24 N	2-4mm
	1483923	BCC 2-4 D30	2-4mm	25-30mm	100	1487514	TKCI 4-30 N	2-4mm
	1483931	BCC 4-7 D5,5	4-7mm	4,5-5,5mm	100	1487530	TKCI 7-5 N	4-7mm
	1483933	BCC 4-7 D7	4-7mm	6-7mm	100	1487532	TKCI 7-7 N	4-7mm
	1483935	BCC 4-7 D9	4-7mm	7-9mm	100	1487534	TKCI 7-9 N	4-7mm
	1483937	BCC 4-7 D11	4-7mm	10-11mm	100	1487536	TKCI 7-12 N	4-7mm
	1483941	BCC 4-7 D14	4-7mm	12-14mm	100	1487538	TKCI 7-14 N	4-7mm
	1483945	BCC 4-7 D18	4-7mm	15-18mm	100	1487540	TKCI 7-18 N	4-7mm
	1483951	BCC 4-7 D24	4-7mm	19-24mm	100	1487542	TKCI 7-24 N	4-7mm
	1483955	BCC 4-7 D30	4-7mm	25-30mm	100	1487544	TKCI 7-30 N	4-7mm
	1483960	BCC 2-4 D5,5	8-12mm	4,5-5,5mm	100	1487560	TKCI 12-5 N	8-12mm
	1483961	BCC 8-12 D7	8-12mm	6-7mm	100	1487562	TKCI 12-7 N	8-12mm
	1483963	BCC 8-12 D9	8-12mm	7-9mm	100	1487564	TKCI 12-9 N	8-12mm
	1483965	BCC 8-12 D11	8-12mm	10-11mm	100	1487566	TKCI 12-12 N	8-12mm
	1483969	BCC 8-12 D14	8-12mm	12-14mm	100	1487568	TKCI 12-14 N	8-12mm
	1483973	BCC 8-12 D18	8-12mm	15-18mm	100	1487570	TKCI 12-18 N	8-12mm
	1483977	BCC 8-12 D24	8-12mm	19-24mm	100	1487572	TKCI 12-24 N	8-12mm
	1483981	BCC 8-12 D30	8-12mm	25-30mm	100	1487574	TKCI 12-30 N	8-12mm
	1483999	BCCA	12-20mm		100	1487496	TKCI-A	12-20mm
	1483985	BCCF 3-7 D20	8-11mm		100	1487728	TC 9-20 ZD	8-9mm

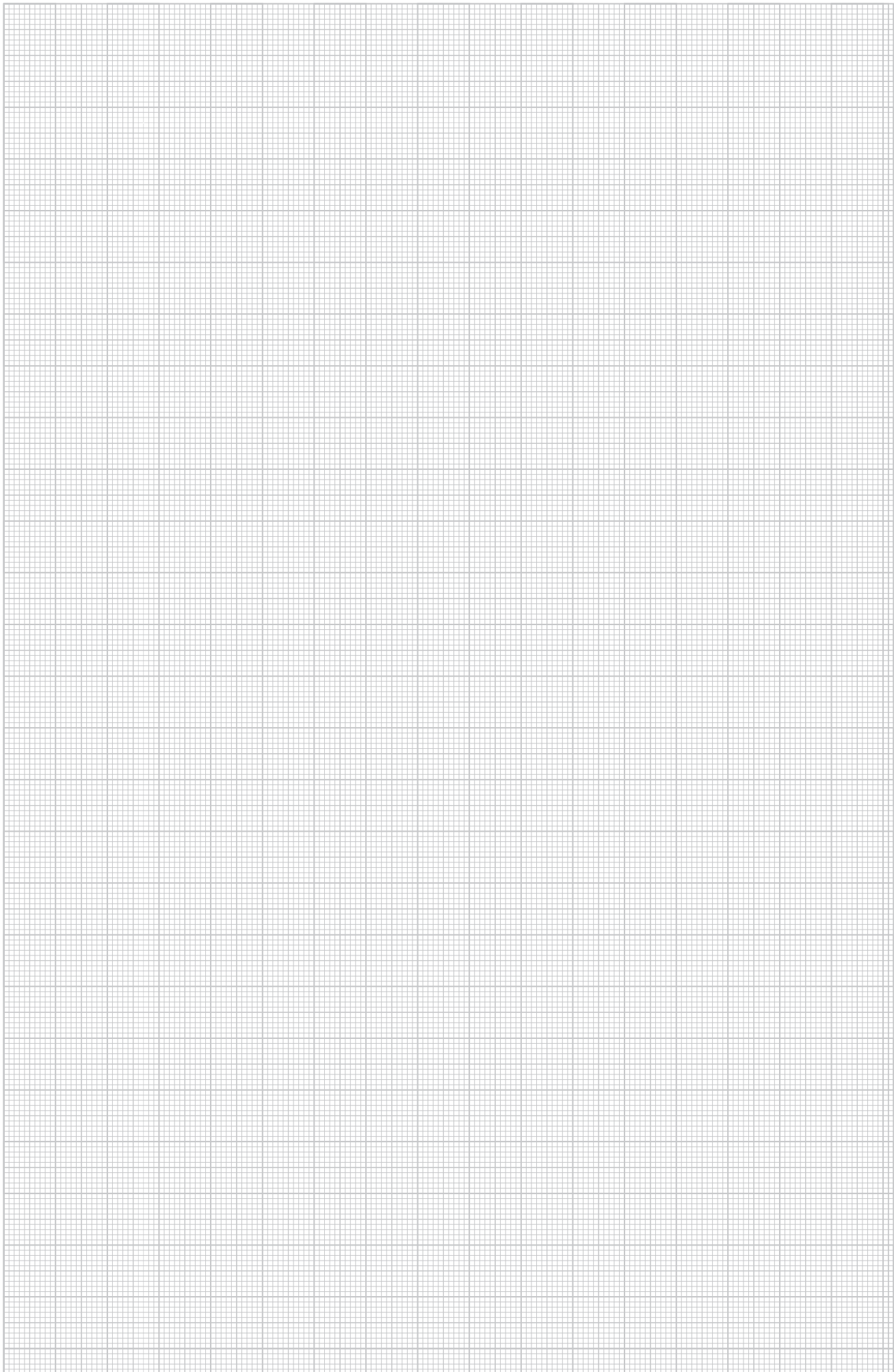

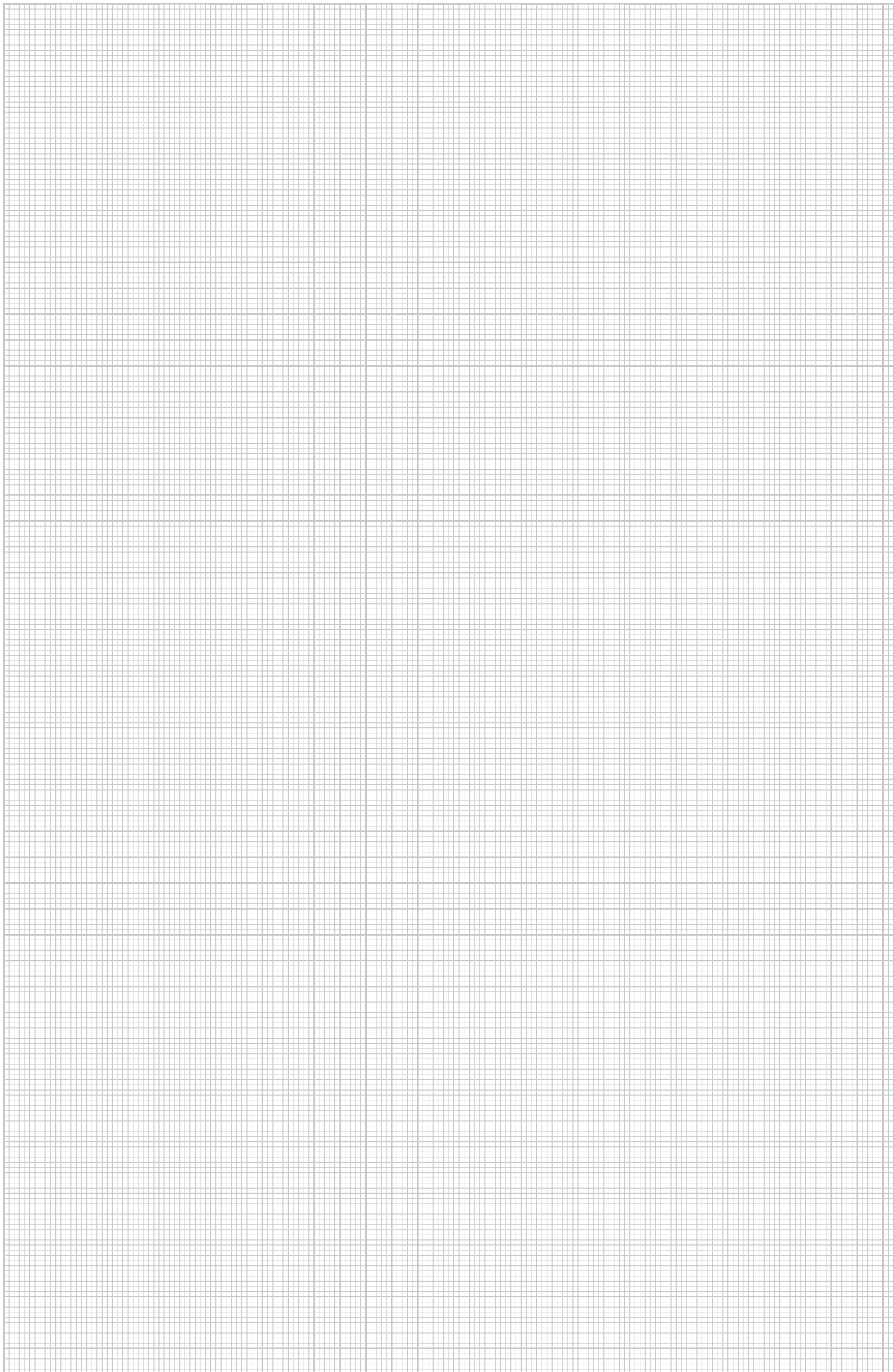

OBO Bettermann S.A.

Parque Empresarial Argame, C/ Mostayal D13
33163 Argame
ESPAÑA

Centro de Atención al Cliente

Tel.: +34 985 796 968
Fax: +34 985 796 949
info@obo.es

www.obo.es

